

LANGENDORF SKA 24/30 ISOXX GEISOLEERD



Itemno 275266
Kind Semi-trailer
Specification Tipper
Matriculation year 2016 / 04
Mileage

Chassisnumber
WLASKA339GWF66197

Technical condition

Remarks

(A15)

Price €14900

KLEYN TRUCKS

KLEYN GROUP **KLEYN** VANS **KLEYN** TRAILERS **KLEYN** SERVICES

Kleyn Trucks B.V.®
PO Box 3
4214 ZJ Vuren
Industrieweg 2
4214 KZ Vuren
The Netherlands

IBAN: NL91RABO0103247157
SWIFT/BIC: RABONL2U

KvK 11013784
BTW/VAT NL004676841B01

Equipment

Chassis

Number of axles 3
Own weight 5,680 kg
Gross vehicle weight 39,000 kg
Chassis type Complete chassis
Chassis material steel
Kingpin size 2 inch
Aluminium rims
Suspension type full air suspension

Cabin

Color Silver

Drivetrain

Engine capacity (0 Hp)
ABS
EBS

Superstructure

Matr. year superstructure 2,016
Material superstructure aluminium
Tipping possibilities 1 side
Inner box length 725 cm
Inner box width 230 cm
Inner box height 165 cm
Bulk capacity 27
Bulkcontent measure m3

Axle

Axle make BPW

Contact information



info@kleyn.com
Tel: +31 183 668 222

Certified and professional



Kleyn Trucks differentiates itself from its competitors by offering expert technical services, safety inspections and repair.

Dimensions

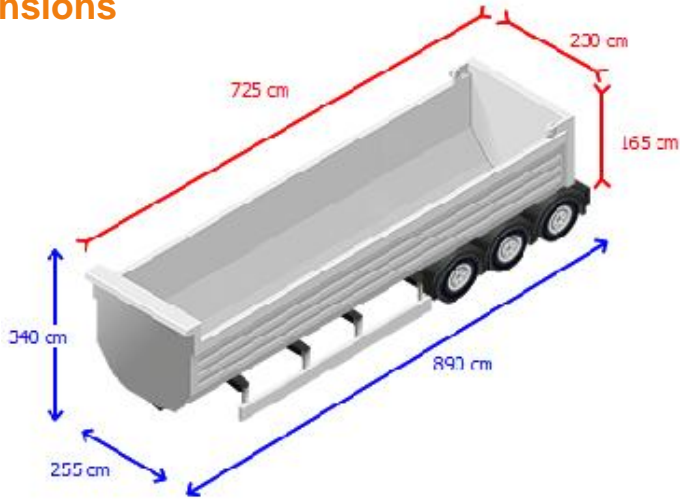

KLEYN TRUCKS

KLEYN GROUP KLEYN VANS KLEYN TRAILERS KLEYN SERVICES

Kleyn Trucks B.V.®
PO Box 3
4214 ZJ Vuren
Industrieweg 2
4214 KZ Vuren
The Netherlands

IBAN: NL91RABO0103247157
SWIFT/BIC: RABONL2U

KvK 11013784
BTW/VAT NL004676841B01

Inspection report

Superstructure

Internal condition

External condition

Tyres/Wheels

Tyres

Tires and axles



Tire size: 385/65R22,5
Lift axle
air suspension
Drum brakes



Tire size: 385/65R22,5
air suspension
Drum brakes



Tire size: 385/65R22,5
air suspension
Drum brakes

Contact information



info@kleyn.com
Tel: +31 183 668 222

Legenda for inspection report

Very good state
 Good state
 Reasonable state
 Moderate state
 Does not meet requirements